

LM5111

Dual 5A Compound Gate Driver

General Description

The LM5111 Dual Gate Driver replaces industry standard gate drivers with improved peak output current and efficiency. Each “compound” output driver stage includes MOS and bipolar transistors operating in parallel that together sink more than 5A peak from capacitive loads. Combining the unique characteristics of MOS and bipolar devices reduces drive current variation with voltage and temperature. Under-voltage lockout protection is also provided. The drivers can be operated in parallel with inputs and outputs connected to double the drive current capability. This device is available in the SOIC-8 package or the thermally enhanced MSOP8-EP package.

Features

- Independently drives two N-Channel MOSFETs
- Compound CMOS and bipolar outputs reduce output current variation
- 5A sink/3A source current capability
- Two channels can be connected in parallel to double the drive current

- Independent inputs (TTL compatible)
- Fast propagation times (25 ns typical)
- Fast rise and fall times (14 ns/12 ns rise/fall with 2 nF load)
- Available in dual non-inverting, dual inverting and combination configurations
- Supply rail under-voltage lockout protection (UVLO)
- LM5111-4 UVLO configured to drive PFET through OUT_A and NFET through OUT_B
- Pin compatible with industry standard gate drivers

Typical Applications

- Synchronous Rectifier Gate Drivers
- Switch-mode Power Supply Gate Driver
- Solenoid and Motor Drivers

Packages

- SOIC-8
- Thermally Enhanced MSOP8-EP

Connection Diagram

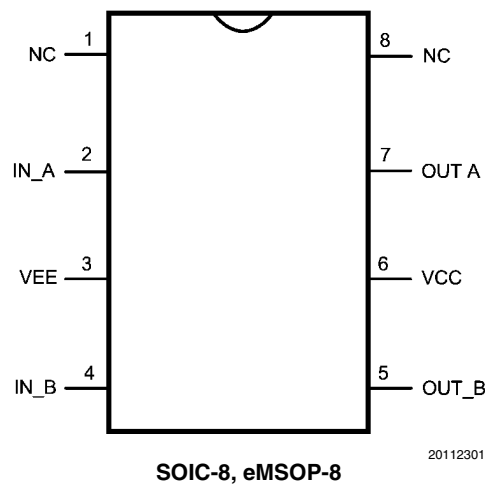

Ordering Information

Order Number	Package Type	NSC Package Drawing	Supplied As
LM5111-1M	SOIC-8	M08A	Shipped in anti-static units, 95 Units/Rail
LM5111-1MX	SOIC-8	M08A	2500 shipped in Tape & Reel
LM5111-2M	SOIC-8	M08A	Shipped in anti-static units, 95 Units/Rail
LM5111-2MX	SOIC-8	M08A	2500 shipped in Tape & Reel
LM5111-3M	SOIC-8	M08A	Shipped in anti-static units, 95 Units/Rail
LM5111-3MX	SOIC-8	M08A	2500 shipped in Tape & Reel
LM5111-1MY	MSOP8-EP	MUY08A	1000 shipped in Tape & Reel
LM5111-1MYX	MSOP8-EP	MUY08A	3500 shipped in Tape & Reel
LM5111-2MY	MSOP8-EP	MUY08A	1000 shipped in Tape & Reel
LM5111-2MYX	MSOP8-EP	MUY08A	3500 shipped in Tape & Reel
LM5111-3MY	MSOP8-EP	MUY08A	1000 shipped in Tape & Reel
LM5111-3MYX	MSOP8-EP	MUY08A	3000 shipped in Tape & Reel
LM5111-4M	SOIC-8	M08A	Shipped in anti-static units, 95 Units/Rail
LM5111-4MX	SOIC-8	M08A	2500 shipped in Tape & Reel
LM5111-4MY	MSOP8-EP	MUY08A	1000 shipped in Tape & Reel
LM5111-4MYX	MSOP8-EP	MUY08A	3500 shipped in Tape & Reel

Pin Descriptions

Pin	Name	Description	Application Information
1	NC	No Connect	
2	IN_A	'A' side control input	TTL compatible thresholds.
3	VEE	Ground reference for both inputs and outputs	Connect to power ground.
4	IN_B	'B' side control input	TTL compatible thresholds.
5	OUT_B	Output for the 'B' side driver.	Voltage swing of this output is from VCC to VEE. The output stage is capable of sourcing 3A and sinking 5A.
6	VCC	Positive output supply	Locally decouple to VEE.
7	OUT_A.	Output for the 'A' side driver.	Voltage swing of this output is from VCC to VEE. The output stage is capable of sourcing 3A and sinking 5A.
8	NC	No Connect	

Configuration Table

Part Number	"A" Output Configuration	"B" Output Configuration	Package
LM5111-1M/-1MX/-1MY/-1MYX	Non-Inverting (Low in UVLO)	Non-Inverting (Low in UVLO)	SOIC-8, MSOP8-EP
LM5111-2M/-2MX/-2MY/-2MYX	Inverting (Low in UVLO)	Inverting (Low in UVLO)	SOIC-8, MSOP8-EP
LM5111-3M/-3MX/-3MY/-3MYX	Inverting (Low in UVLO)	Non-Inverting (Low in UVLO)	SOIC-8, MSOP8-EP
LM5111-4M/-4MX/-4MY/-4MYX	Inverting (High in UVLO)	Non-Inverting (Low in UVLO)	SOIC-8, MSOP8-EP

Absolute Maximum Ratings (Note 1)

If Military/Aerospace specified devices are required, please contact the National Semiconductor Sales Office/Distributors for availability and specifications.

V_{CC} to V_{EE}	-0.3V to 15V
IN to V_{EE}	-0.3V to 15V

Storage Temperature Range, (T_{STG})	-55°C to +150°C
Maximum Junction Temperature, ($T_J(\max)$)	+150°C
Operating Junction Temperature	+125°C
ESD Rating	2kV

Electrical Characteristics

$T_J = -40^\circ\text{C}$ to $+125^\circ\text{C}$, $V_{CC} = 12\text{V}$, $V_{EE} = 0\text{V}$, No Load on OUT_A or OUT_B, unless otherwise specified.

Symbol	Parameter	Conditions	Min	Typ	Max	Units
	V_{CC} Operating Range	$V_{CC}-V_{EE}$	3.5		14	V
V_{CCR}	V_{CC} Under Voltage Lockout (rising)	$V_{CC}-V_{EE}$	2.3	2.9	3.5	V
V_{CCH}	V_{CC} Under Voltage Lockout Hysteresis			230		mV
I_{CC}	V_{CC} Supply Current (I_{CC})	IN_A = IN_B = 0V (5111-1)		1	2	mA
		IN_A = IN_B = V_{CC} (5111-2)		1	2	
		IN_A = V_{CC} , IN_B = 0V (5111-3)		1	2	

CONTROL INPUTS

V_{IH}	Logic High		2.2			V
V_{IL}	Logic Low				0.8	V
V_{thH}	High Threshold		1.3	1.75	2.2	V
V_{thL}	Low Threshold		0.8	1.35	2.0	V
HYS	Input Hysteresis			400		mV
I_{IL}	Input Current Low	IN_A=IN_B= V_{CC} (5111-1-2-3)	-1	0.1	1	μA
I_{IH}	Input Current High	IN_B= V_{CC} (5111-3)	10	18	25	
		IN_A=IN_B= V_{CC} (5111-2)	-1	0.1	1	
		IN_A=IN_B= V_{CC} (5111-1)	10	18	25	
		IN_A= V_{CC} (5111-3)	-1	0.1	1	

OUTPUT DRIVERS

R_{OH}	Output Resistance High	$I_{OUT} = -10\text{ mA}$ (Note 2)		30	50	Ω
R_{OL}	Output Resistance Low	$I_{OUT} = +10\text{ mA}$ (Note 2)		1.4	2.5	Ω
I_{Source}	Peak Source Current	OUTA/OUTB = $V_{CC}/2$, 200 ns Pulsed Current		3		A
I_{Sink}	Peak Sink Current	OUTA/OUTB = $V_{CC}/2$, 200 ns Pulsed Current		5		A

Symbol	Parameter	Conditions	Min	Typ	Max	Units
SWITCHING CHARACTERISTICS						
td1	Propagation Delay Time Low to High, IN rising (IN to OUT)	$C_{LOAD} = 2 \text{ nF}$, see <i>Figure 1</i>		25	40	ns
td2	Propagation Delay Time High to Low, IN falling (IN to OUT)	$C_{LOAD} = 2 \text{ nF}$, see <i>Figure 1</i>		25	40	ns
t_r	Rise Time	$C_{LOAD} = 2 \text{ nF}$, see <i>Figure 1</i>		14	25	ns
t_f	Fall Time	$C_{LOAD} = 2 \text{ nF}$, see <i>Figure 1</i>		12	25	ns
LATCHUP PROTECTION						
	AEC - Q100, Method 004	$T_J = 150^\circ\text{C}$		500		mA
THERMAL RESISTANCE						
θ_{JA}	Junction to Ambient, 0 LFPM Air Flow	SOIC-8 Package MSOP8-EP Package		170 60		$^\circ\text{C/W}$
θ_{JC}	Junction to Case	SOIC-8 Package MSOP8-EP Package		70 4.7		$^\circ\text{C/W}$

Note 1: Absolute Maximum Ratings are limits beyond which damage to the device may occur. Operating Ratings are conditions under which operation of the device is intended to be functional. For guaranteed specifications and test conditions, see the Electrical Characteristics.

Note 2: The output resistance specification applies to the MOS device only. The total output current capability is the sum of the MOS and Bipolar devices.

Timing Waveforms

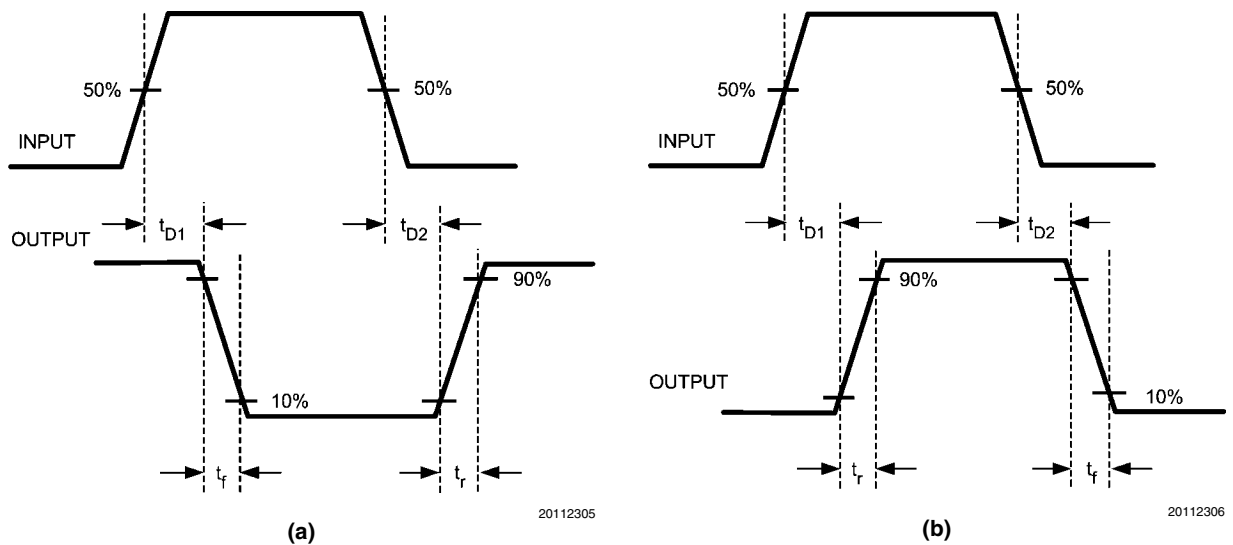
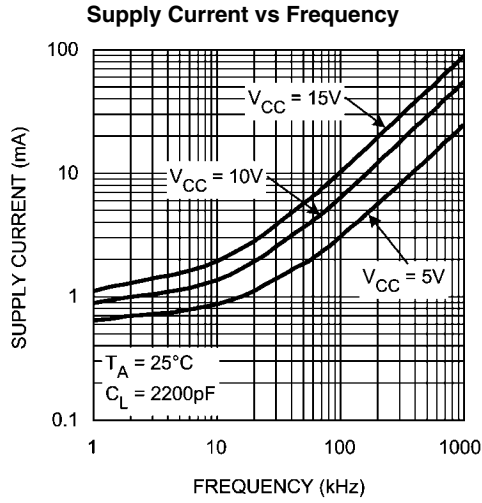
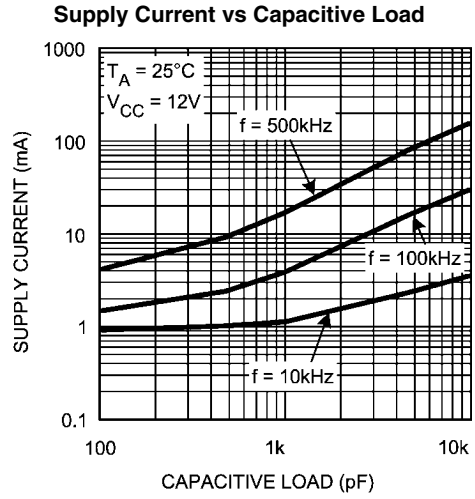

FIGURE 1. (a) Inverting, (b) Non-Inverting

Typical Performance Characteristics



20112310



20112311

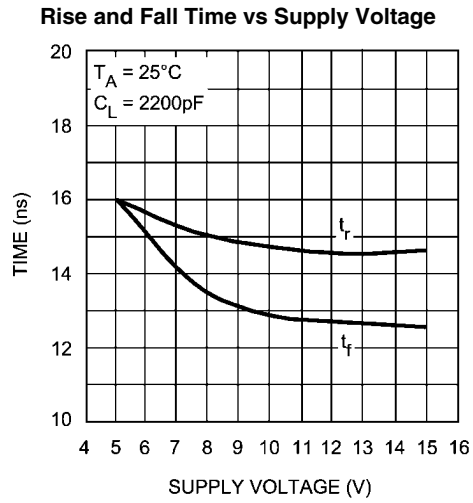

20112312

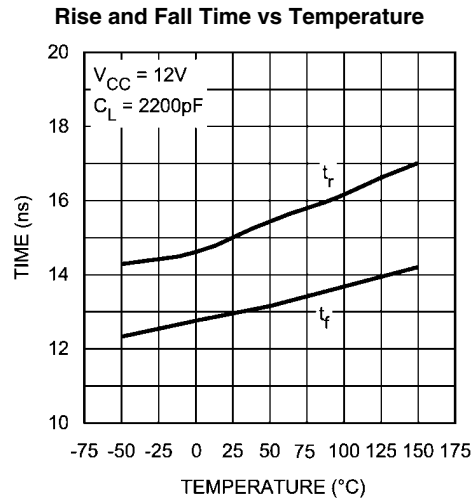

20112313

Rise and Fall Time vs Capacitive Load

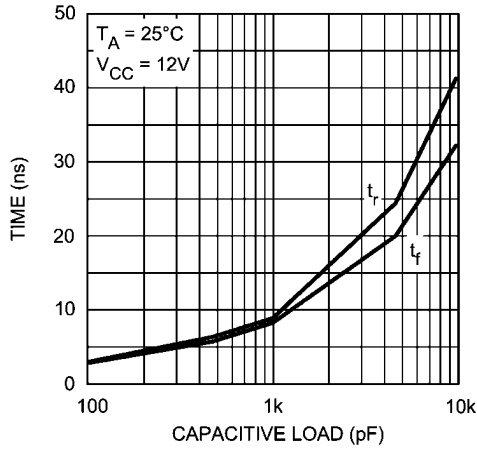

20112314

Delay Time vs Supply Voltage

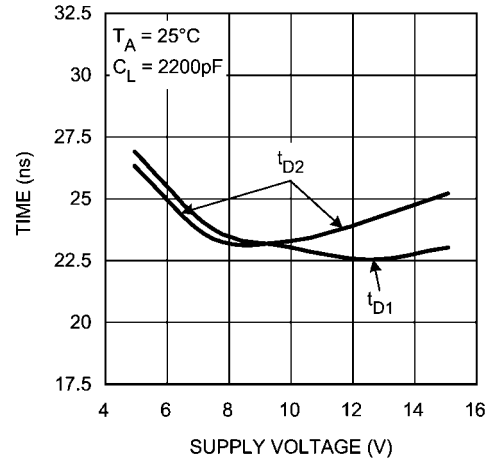

20112315

Delay Time vs Temperature

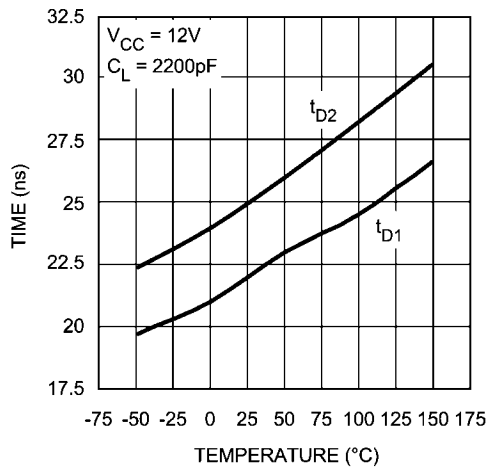

20112316

RDSON vs Supply Voltage

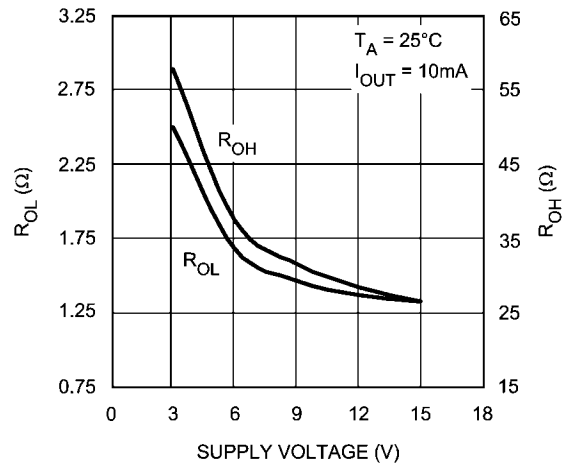

20112317

UVLO Thresholds and Hysteresis vs Temperature

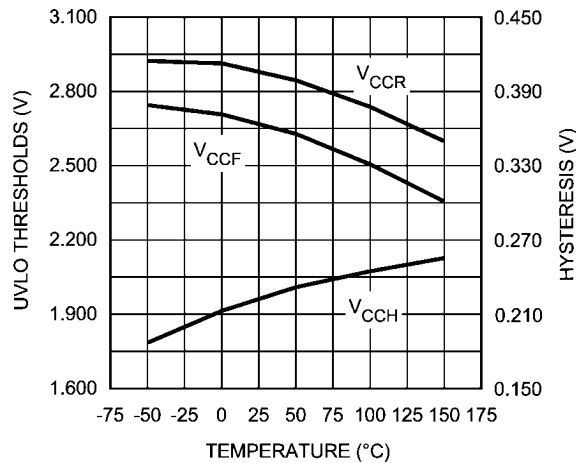

20112318

Block Diagram

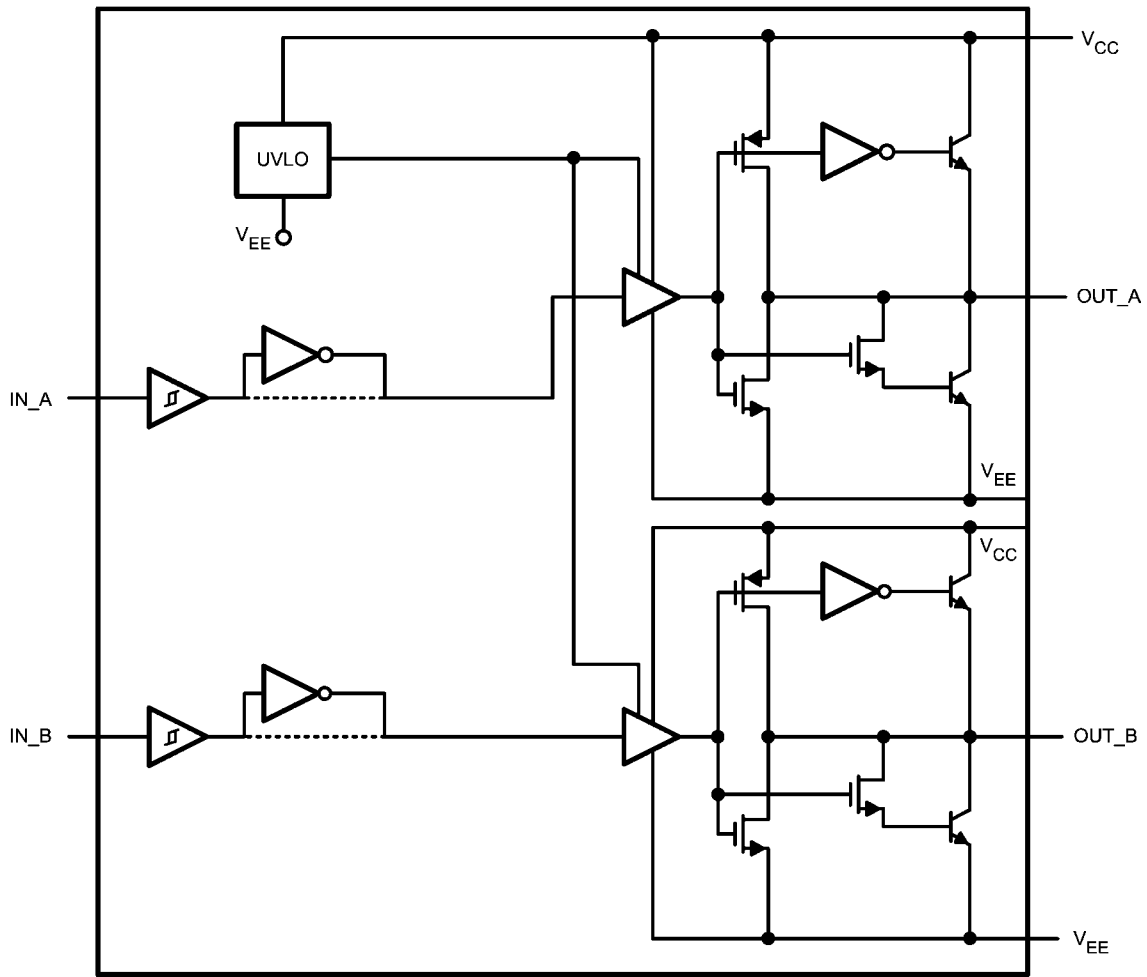

Block Diagram of LM5111

20112303

Detailed Operating Description

LM5111 dual gate driver consists of two independent and identical driver channels with TTL compatible logic inputs and high current totem-pole outputs that source or sink current to drive MOSFET gates. The driver output consist of a compound structure with MOS and bipolar transistor operating in parallel to optimize current capability over a wide output voltage and operating temperature range. The bipolar device provides high peak current at the critical threshold region of the MOSFET VGS while the MOS devices provide rail-to-rail output swing. The totem pole output drives the MOSFET gate between the gate drive supply voltage V_{CC} and the power ground potential at the V_{EE} pin.

The control inputs of the drivers are high impedance CMOS buffers with TTL compatible threshold voltages. The LM5111 pinout was designed for compatibility with industry standard gate drivers in single supply gate driver applications.

The input stage of each driver should be driven by a signal with a short rise and fall time. Slow rising and falling input signals, although not harmful to the driver, may result in the output switching repeatedly at a high frequency.

The two driver channels of the LM5111 are designed as identical cells. Transistor matching inherent to integrated circuit manufacturing ensures that the AC and DC performance of the channels are nearly identical. Closely matched propagation delays allow the dual driver to be operated as a single with inputs and output pins connected. The drive current capability in parallel operation is precisely 2X the drive of an individual channel. Small differences in switching speed between the driver channels will produce a transient current (shoot-through) in the output stage when two output pins are connected to drive a single load. Differences in input thresholds between the driver channels will also produce a transient current (shoot-through) in the output stage. Fast transition input signals are especially important while operating in a parallel configuration. The efficiency loss for parallel operation has been characterized at various loads, supply voltages and operating frequencies. The power dissipation in the LM5111 increases by less than 1% relative to the dual driver configuration when operated as a single driver with inputs/ outputs connected.

An Under Voltage Lock Out (UVLO) circuit is included in the LM5111, which senses the voltage difference between V_{CC} and the chip ground pin, V_{EE} . When the V_{CC} to V_{EE} voltage difference falls below 2.8V both driver channels are disabled. The UVLO hysteresis prevents chattering during brown-out conditions and the driver will resume normal operation when the V_{CC} to V_{EE} differential voltage exceeds approximately 3.0V.

The LM5111-1, -2 and -3 devices hold both outputs in the low state in the under-voltage lockout (UVLO) condition. The LM5111-4 is distinguished from the LM5111-3 by the active high output state of OUT_A during UVLO. When VCC is less than the UVLO threshold voltage, OUT_A of the LM5111-4 will be locked in the high state while OUT_B will be disabled in the low state. This configuration allows the LM5111-4 to drive a PFET through OUT_A and an NFET through OUT_B with both FETs safely turned off during UVLO.

The LM5111 is available in dual non-inverting (-1), dual Inverting (-2) and the combination inverting plus non-inverting (-3, -4) configurations. All configurations are offered in the SOIC-8 and MSOP8-EP plastic packages.

Layout Considerations

Attention must be given to board layout when using LM5111. Some important considerations include:

1. A Low ESR/ESL capacitor must be connected close to the IC and between the V_{CC} and V_{EE} pins to support high peak currents being drawn from V_{CC} during turn-on of the MOSFET.
2. Proper grounding is crucial. The drivers need a very low impedance path for current return to ground avoiding inductive loops. The two paths for returning current to ground are a) between LM5111 V_{EE} pin and the ground of the circuit that controls the driver inputs, b) between LM5111 V_{EE} pin and the source of the power MOSFET being driven. All these paths should be as short as possible to reduce inductance and be as wide as possible to reduce resistance. All these ground paths should be kept distinctly separate to avoid coupling between the high current output paths and the logic signals that drive the LM5111. A good method is to dedicate one copper plane in a multi-layered PCB to provide a common ground surface.
3. With the rise and fall times in the range of 10 ns to 30 ns, care is required to minimize the lengths of current carrying conductors to reduce their inductance and EMI from the high di/dt transients generated by the LM5111.
4. The LM5111 footprint is compatible with other industry standard drivers including the TC4426/27/28 and UCC27323/4/5.
5. If either channel is not being used, the respective input pin (IN_A or IN_B) should be connected to either V_{EE} or V_{CC} to avoid spurious output signals.

Thermal Performance

INTRODUCTION

The primary goal of thermal management is to maintain the integrated circuit (IC) junction temperature (T_J) below a specified maximum operating temperature to ensure reliability. It is essential to estimate the maximum T_J of IC components in worst case operating conditions. The junction temperature is estimated based on the power dissipated in the IC and the junction to ambient thermal resistance θ_{JA} for the IC package in the application board and environment. The θ_{JA} is not a given constant for the package and depends on the printed circuit board design and the operating environment.

DRIVE POWER REQUIREMENT CALCULATIONS IN LM5111

The LM5111 dual low side MOSFET driver is capable of sourcing/sinking 3A/5A peak currents for short intervals to drive a MOSFET without exceeding package power dissipation limits. High peak currents are required to switch the MOSFET gate very quickly for operation at high frequencies.

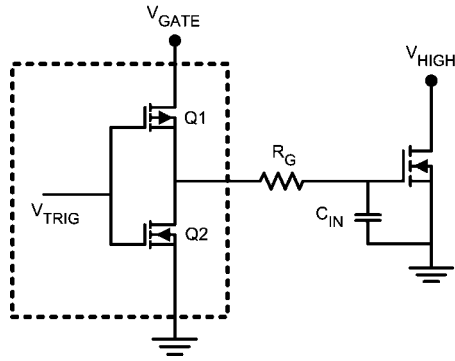

20112307

FIGURE 2.

The schematic above shows a conceptual diagram of the LM5111 output and MOSFET load. Q1 and Q2 are the switches within the gate driver. R_G is the gate resistance of the external MOSFET, and C_{IN} is the equivalent gate capacitance of the MOSFET. The gate resistance R_G is usually very small and losses in it can be neglected. The equivalent gate capacitance is a difficult parameter to measure since it is the combination of C_{GS} (gate to source capacitance) and C_{GD} (gate to drain capacitance). Both of these MOSFET capacitances are not constants and vary with the gate and drain voltage. The better way of quantifying gate capacitance is the total gate charge Q_G in coulombs. Q_G combines the charge required by C_{GS} and C_{GD} for a given gate drive voltage V_{GATE} .

Assuming negligible gate resistance, the total power dissipated in the MOSFET driver due to gate charge is approximated by

$$P_{DRIVER} = V_{GATE} \times Q_G \times F_{SW}$$

Where

F_{SW} = switching frequency of the MOSFET.

For example, consider the MOSFET MTD6N15 whose gate charge specified as 30 nC for $V_{GATE} = 12V$.

The power dissipation in the driver due to charging and discharging of MOSFET gate capacitances at switching frequency of 300 kHz and V_{GATE} of 12V is equal to

$$P_{DRIVER} = 12V \times 30 \text{ nC} \times 300 \text{ kHz} = 0.108W.$$

If both channels of the LM5111 are operating at equal frequency with equivalent loads, the total losses will be twice as this value which is 0.216W.

In addition to the above gate charge power dissipation, - transient power is dissipated in the driver during output transitions. When either output of the LM5111 changes state, current will flow from V_{CC} to V_{EE} for a very brief interval of time through the output totem-pole N and P channel MOSFETs. The final component of power dissipation in the driver is the power associated with the quiescent bias current consumed by the driver input stage and Under-voltage lockout sections.

Characterization of the LM5111 provides accurate estimates of the transient and quiescent power dissipation components. At 300 kHz switching frequency and 30 nC load used in the example, the transient power will be 8 mW. The 1 mA nominal quiescent current and 12V V_{GATE} supply produce a 12 mW typical quiescent power.

Therefore the total power dissipation

$$P_D = 0.216 + 0.008 + 0.012 = 0.236W.$$

We know that the junction temperature is given by

$$T_J = P_D \times \theta_{JA} + T_A$$

Or the rise in temperature is given by

$$T_{RISE} = T_J - T_A = P_D \times \theta_{JA}$$

For SOIC-8 package θ_{JA} is estimated as 170°C/W for the conditions of natural convection. For MSOP8-EP θ_{JA} is typically 60°C/W.

Therefore for SOIC T_{RISE} is equal to

$$T_{RISE} = 0.236 \times 170 = 40.1^\circ C$$

CONTINUOUS CURRENT RATING OF LM5111

The LM5111 can deliver pulsed source/sink currents of 3A and 5A to capacitive loads. In applications requiring continuous load current (resistive or inductive loads), package power dissipation, limits the LM5111 current capability far below the 5A sink/3A source capability. Rated continuous current can be estimated both when sourcing current to or sinking current from the load. For example when sinking, the maximum sink current can be calculated as:

$$I_{SINK} (MAX) := \sqrt{\frac{T_J(MAX) - T_A}{\theta_{JA} \cdot R_{DS} (ON)}}$$

where $R_{DS}(on)$ is the on resistance of lower MOSFET in the output stage of LM5111.

Consider $T_J(max)$ of 125°C and θ_{JA} of 170°C/W for an SO-8 package under the condition of natural convection and no air flow. If the ambient temperature (T_A) is 60°C, and the $R_{DS}(on)$ of the LM5111 output at $T_J(max)$ is 2.5Ω, this equation yields $I_{SINK}(max)$ of 391mA which is much smaller than 5A peak pulsed currents.

Similarly, the maximum continuous source current can be calculated as

$$I_{SOURCE} (MAX) := \frac{T_J(MAX) - T_A}{\theta_{JA} \cdot V_{DIODE}}$$

where V_{DIODE} is the voltage drop across hybrid output stage which varies over temperature and can be assumed to be about 1.1V at $T_J(max)$ of 125°C. Assuming the same parameters as above, this equation yields $I_{SOURCE}(max)$ of 347mA.

Physical Dimensions inches (millimeters) unless otherwise noted

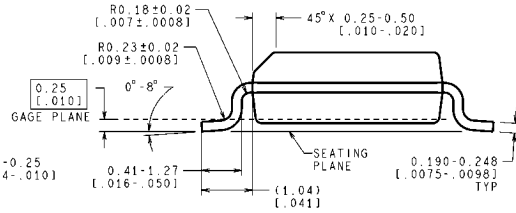
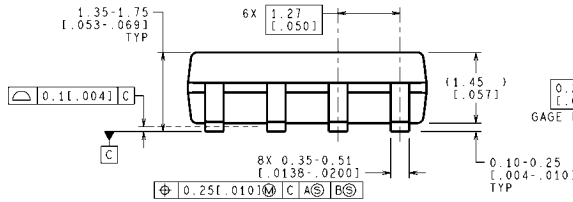
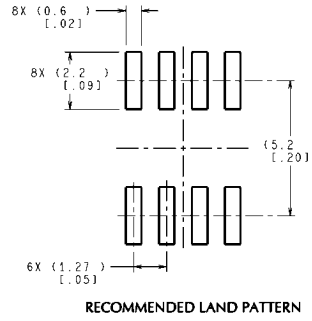
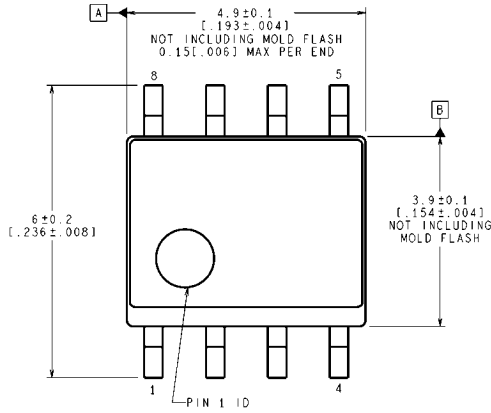

CONTROLLING DIMENSION IS MILLIMETER
VALUES IN [] ARE INCHES
DIMENSIONS IN () FOR REFERENCE ONLY

M08A (Rev L)

NOTES: UNLESS OTHERWISE SPECIFIED

- STANDARD LEAD FINISH TO BE 200 MICRONS/5.08 MICROMETERS MINIMUM LEAD/TIN(SOLDER) ON COPPER.
- DIMENSION DOES NOT INCLUDE MOLD FLASH.
- REFERENCE JEDEC REGISTRATION MS-012, VARIATION AA, DATED MAY 1990.

**8-Lead SOIC Package
NS Package Number M08A**

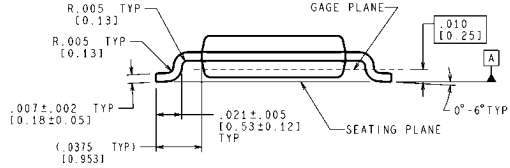
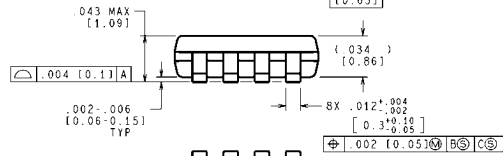
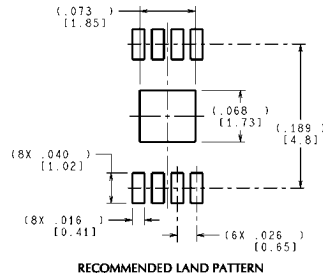
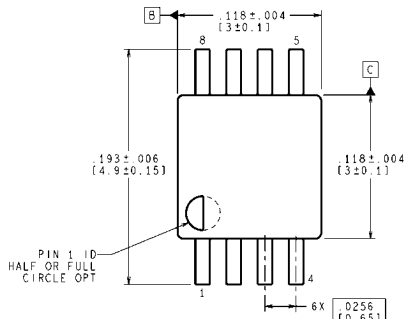

CONTROLLING DIMENSION IS INCH
VALUES IN [] ARE MILLIMETERS

MUY08A (Rev A)

**8-Lead Exposed Pad MSOP Package
NS Package Number MUY08A**

Notes

For more National Semiconductor product information and proven design tools, visit the following Web sites at:

Products		Design Support	
Amplifiers	www.national.com/amplifiers	WEBENCH	www.national.com/webench
Audio	www.national.com/audio	Analog University	www.national.com/AU
Clock Conditioners	www.national.com/timing	App Notes	www.national.com/appnotes
Data Converters	www.national.com/adc	Distributors	www.national.com/contacts
Displays	www.national.com/displays	Green Compliance	www.national.com/quality/green
Ethernet	www.national.com/ethernet	Packaging	www.national.com/packaging
Interface	www.national.com/interface	Quality and Reliability	www.national.com/quality
LVDS	www.national.com/lvds	Reference Designs	www.national.com/refdesigns
Power Management	www.national.com/power	Feedback	www.national.com/feedback
Switching Regulators	www.national.com/switchers		
LDOs	www.national.com/ldo		
LED Lighting	www.national.com/led		
PowerWise	www.national.com/powerwise		
Serial Digital Interface (SDI)	www.national.com/sdi		
Temperature Sensors	www.national.com/tempsensors		
Wireless (PLL/VCO)	www.national.com/wireless		

THE CONTENTS OF THIS DOCUMENT ARE PROVIDED IN CONNECTION WITH NATIONAL SEMICONDUCTOR CORPORATION ("NATIONAL") PRODUCTS. NATIONAL MAKES NO REPRESENTATIONS OR WARRANTIES WITH RESPECT TO THE ACCURACY OR COMPLETENESS OF THE CONTENTS OF THIS PUBLICATION AND RESERVES THE RIGHT TO MAKE CHANGES TO SPECIFICATIONS AND PRODUCT DESCRIPTIONS AT ANY TIME WITHOUT NOTICE. NO LICENSE, WHETHER EXPRESS, IMPLIED, ARISING BY ESTOPPEL OR OTHERWISE, TO ANY INTELLECTUAL PROPERTY RIGHTS IS GRANTED BY THIS DOCUMENT.

TESTING AND OTHER QUALITY CONTROLS ARE USED TO THE EXTENT NATIONAL DEEMS NECESSARY TO SUPPORT NATIONAL'S PRODUCT WARRANTY. EXCEPT WHERE MANDATED BY GOVERNMENT REQUIREMENTS, TESTING OF ALL PARAMETERS OF EACH PRODUCT IS NOT NECESSARILY PERFORMED. NATIONAL ASSUMES NO LIABILITY FOR APPLICATIONS ASSISTANCE OR BUYER PRODUCT DESIGN. BUYERS ARE RESPONSIBLE FOR THEIR PRODUCTS AND APPLICATIONS USING NATIONAL COMPONENTS. PRIOR TO USING OR DISTRIBUTING ANY PRODUCTS THAT INCLUDE NATIONAL COMPONENTS, BUYERS SHOULD PROVIDE ADEQUATE DESIGN, TESTING AND OPERATING SAFEGUARDS.

EXCEPT AS PROVIDED IN NATIONAL'S TERMS AND CONDITIONS OF SALE FOR SUCH PRODUCTS, NATIONAL ASSUMES NO LIABILITY WHATSOEVER, AND NATIONAL DISCLAIMS ANY EXPRESS OR IMPLIED WARRANTY RELATING TO THE SALE AND/OR USE OF NATIONAL PRODUCTS INCLUDING LIABILITY OR WARRANTIES RELATING TO FITNESS FOR A PARTICULAR PURPOSE, MERCHANTABILITY, OR INFRINGEMENT OF ANY PATENT, COPYRIGHT OR OTHER INTELLECTUAL PROPERTY RIGHT.

LIFE SUPPORT POLICY

NATIONAL'S PRODUCTS ARE NOT AUTHORIZED FOR USE AS CRITICAL COMPONENTS IN LIFE SUPPORT DEVICES OR SYSTEMS WITHOUT THE EXPRESS PRIOR WRITTEN APPROVAL OF THE CHIEF EXECUTIVE OFFICER AND GENERAL COUNSEL OF NATIONAL SEMICONDUCTOR CORPORATION. As used herein:

Life support devices or systems are devices which (a) are intended for surgical implant into the body, or (b) support or sustain life and whose failure to perform when properly used in accordance with instructions for use provided in the labeling can be reasonably expected to result in a significant injury to the user. A critical component is any component in a life support device or system whose failure to perform can be reasonably expected to cause the failure of the life support device or system or to affect its safety or effectiveness.

National Semiconductor and the National Semiconductor logo are registered trademarks of National Semiconductor Corporation. All other brand or product names may be trademarks or registered trademarks of their respective holders.

Copyright© 2007 National Semiconductor Corporation

For the most current product information visit us at www.national.com



**National Semiconductor
Americas Customer
Support Center**
Email:
new.feedback@nsc.com
Tel: 1-800-272-9959

**National Semiconductor Europe
Customer Support Center**
Fax: +49 (0) 180-530-85-86
Email: europe.support@nsc.com
Deutsch Tel: +49 (0) 69 9508 6208
English Tel: +49 (0) 870 24 0 2171
Français Tel: +33 (0) 1 41 91 8790

**National Semiconductor Asia
Pacific Customer Support Center**
Email: ap.support@nsc.com

**National Semiconductor Japan
Customer Support Center**
Fax: 81-3-5639-7507
Email: jpn.feedback@nsc.com
Tel: 81-3-5639-7560